

Solutions PETZL pour l'aérocordage

(PETZL solutions for helicopters)

-

DGA

Mercredi 5 décembre 18

Our history

It all began in the 1930s with one man: artisan and caver Fernand Petzl.



Access the inaccessible

Petzl's mission is to create innovative solutions, tools or services, that help people progress in vertical or dark environments.



- Aymeric MANIFICAT
 - Professional markets sales department:
 - French market Manager
 - amanificat@petzl.com



- Benjamin LENGRONNE
 - Product Manager Professional markets:
 - Rope access
 - Rescue
 - Tree Care
 - Tactical



Intro :

- Specific requests on PETZL solutions

Practical examples:

- LEZARD = secured released mechanism
- HELO ADJUST = manual released mechanism

PPE regulation:

- Manufacturer's changes
- PPE inspection and follow-up

Questions / Field feedback

Topic: “Release/disconnect function”

- Release solutions developed ONLY on specific requests
- Opposite approach between **safety** and **release system**
- PETZL does not develop releasable products for mass market.
- Expert use ONLY

Solution 1 : LEZARD

Intro:

- Have you already been confronted with a critical situation during a winch operation?

Field of application:

- LEZARD: lanyard for helicopter evacuation of persons or loads from a belay station.
- Allows drop-off and recovery phases to be secured for a worker connected to a belay station.



Solution 1 : LEZARD

Field of application:

WARNING

The user must ensure proper compatibility between the winch hook and the LEZARD / IGUANE attachment.

Long line

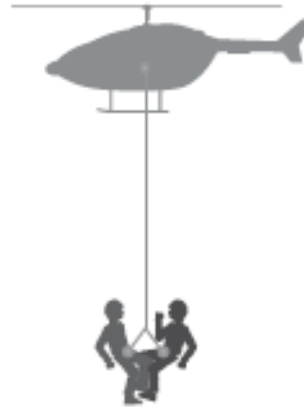

Winching

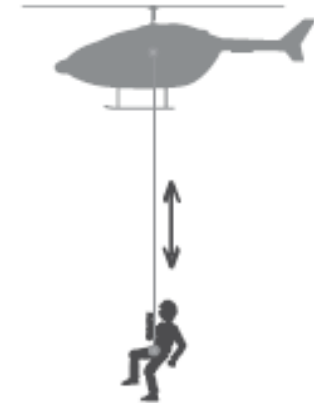

Hook compatibility:



Solution 1 : LEZARD

Easy manipulation:

Instant identification of the attachment elements



Solution 1 : LEZARD

Working principle:

Drop-off or recovery phase in a critical situation: in case the helicopter leaves unexpectedly (e.g. turbulence), the LEZARD releases its tail. The tail remains attached to the belay, and the worker stay attached to the helicopter.

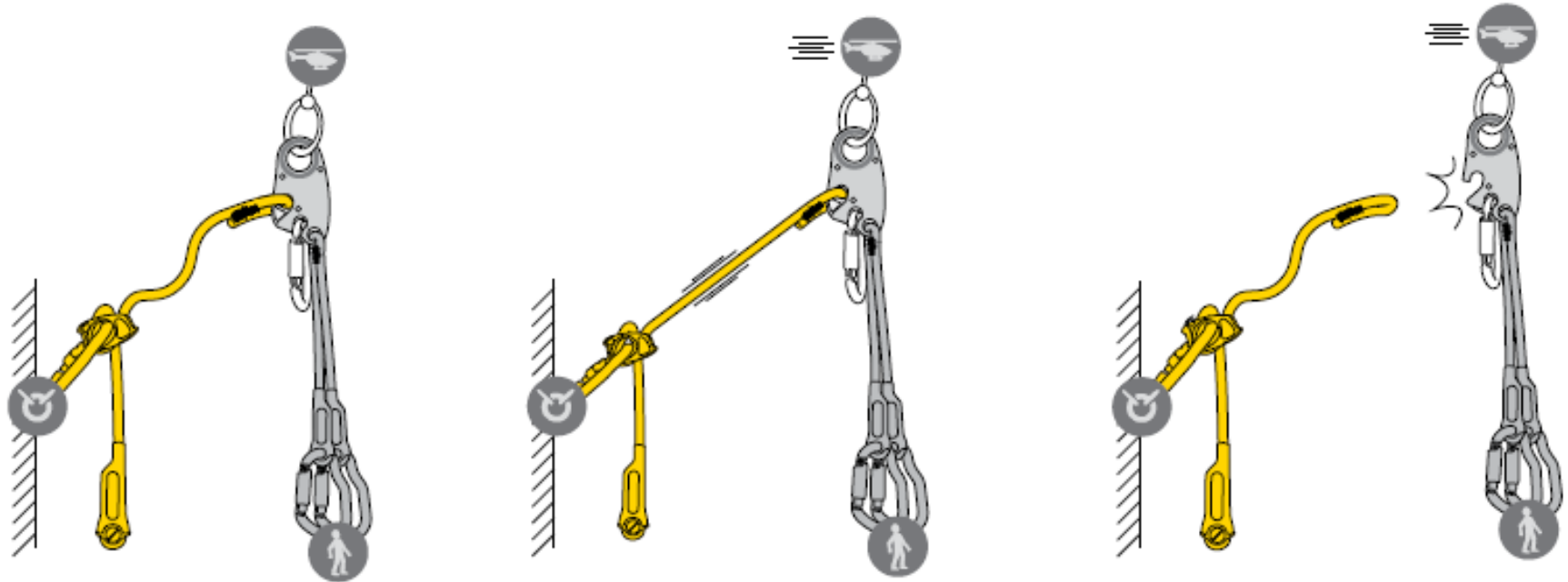

Solution 1 : LEZARD

Technical explanations:

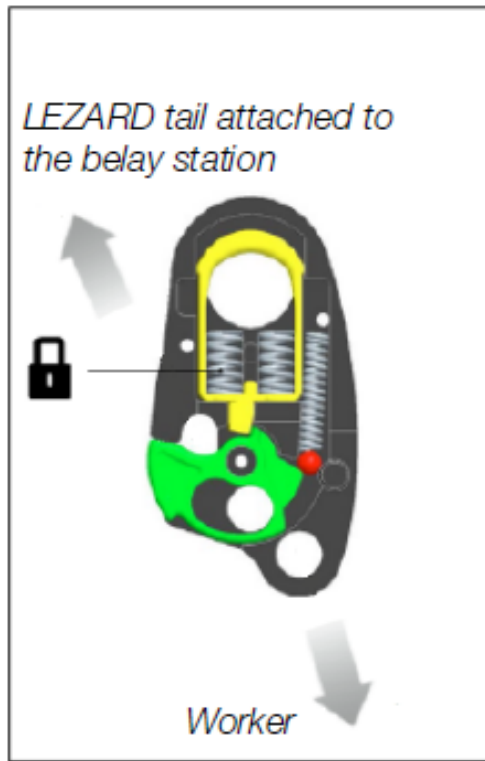

1. Worker at the belay station

Without any action on the lock in the LEZARD eye, there is no risk of release.

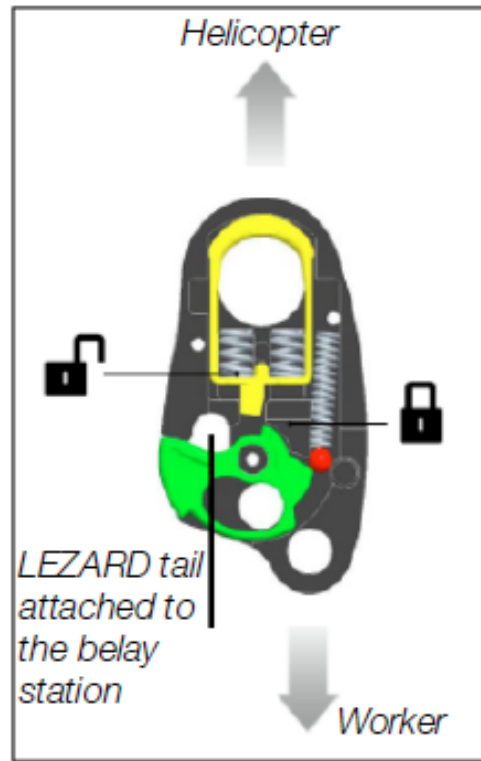

2. Winching phase

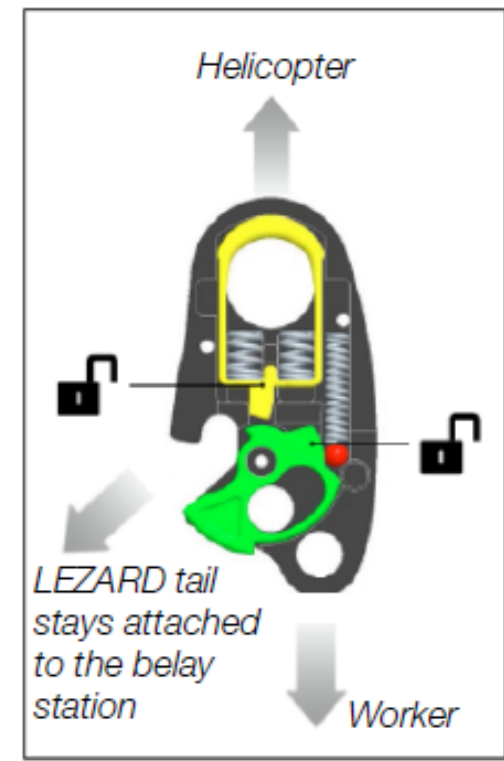

3. Release situation

Solution 1 : LEZARD

Specs:

- Weight: 880g
- Semi-static rope
- LEZARD tail max length: 95cm
- LEZARD tail replaceable

- Certification: CE
- Pat. Pending

- Sales conditions:
 - Specific training mandatory
 - Make to order (No stock)



Solution 1 : LEZARD

Other use: Worker on a pylone (upon US request)

Phase 1:

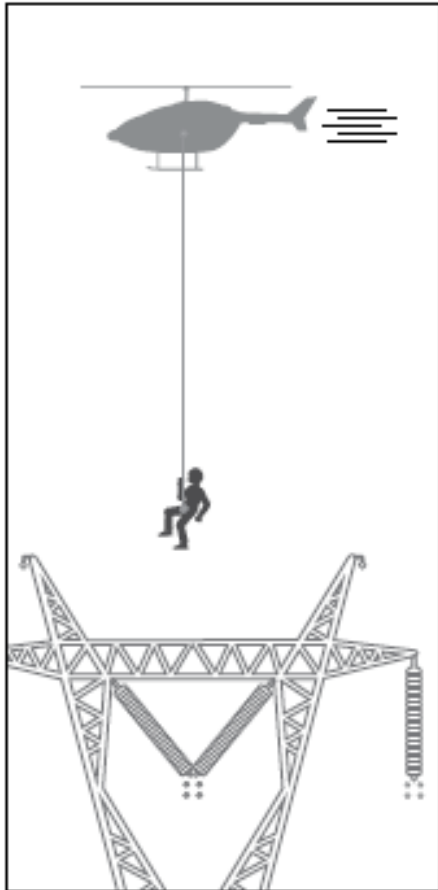

Worker approach

Phase 2:

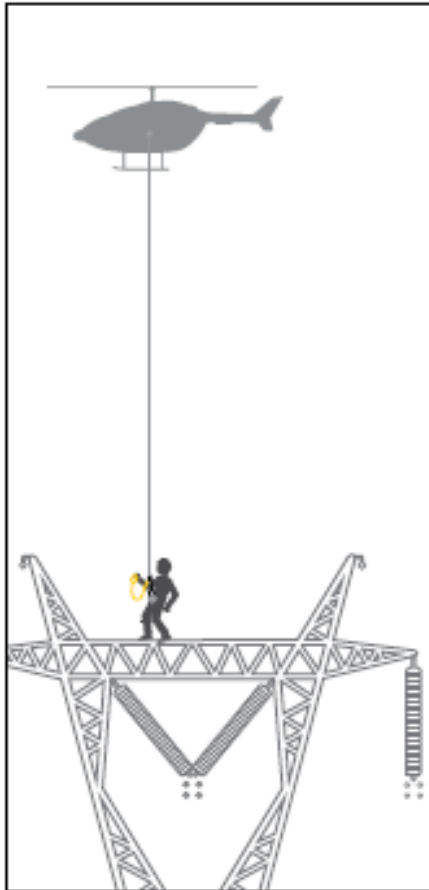

Drop-off Worker

Phase 3:

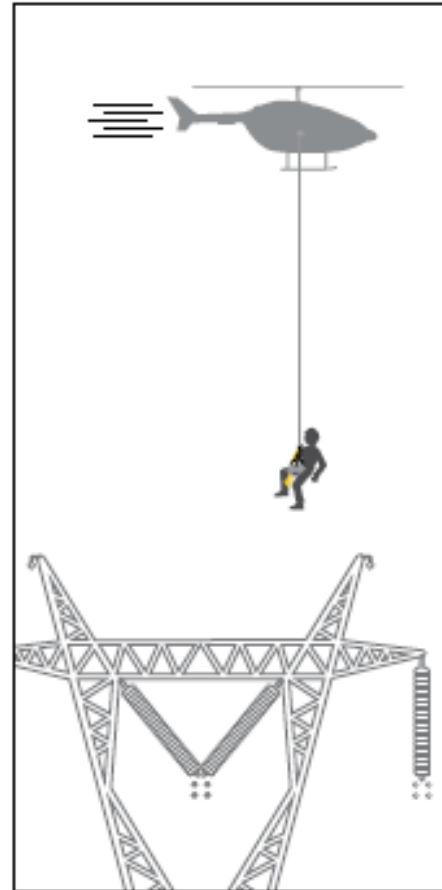

Recovery

Solution 1 : LEZARD

Different configurations:



Field experiences: French/Swiss markets

- Private company: AIR GLACIERS / Sion from 2015
- Public companies:
 - SDIS 04 / 64 / 73 / 74 from 2016 to 2018
 - CRS from 2016
 - DGGN from 2016
- Conclusion: very positive feedback, very appreciated solution thanks to its features

Solution 2 : HELO ADJUST



Solution 2 : HELO ADJUST

Intro:

- Releasable, adjustable restraint designed for Military and Law Enforcement use in helicopters
- Initial request from US R&D Special Forces (2017)
- HELO ADJUST complies with Safety Belt & Lanyard US specs (NATICK)



Solution 2 : HELO ADJUST

Field of application:

- HELO ADJUST is a restraint device intended to limit passenger movement while traveling inside of helicopters, when seat belts or other restraint systems are not available or mission-appropriate.



Solution 2 : HELO ADJUST

Easy manipulation: one-hand adjustable/releasable restraint tether

The unique aluminum adjuster allows the operator to easily extend and/or shorten the tether with one hand



The EASHOOK OPEN includes an automatic locking feature which facilitates rapid connection /disconnection from an anchor point



Solution 2 : HELO ADJUST

Working principle:

When the adjuster is rotated, the tether can easily be extended. Simply pull the free end of the rope to shorten. When the tether is weighted, the rope automatically locks in the adjuster.

Extend the tether
Agrandir la longe

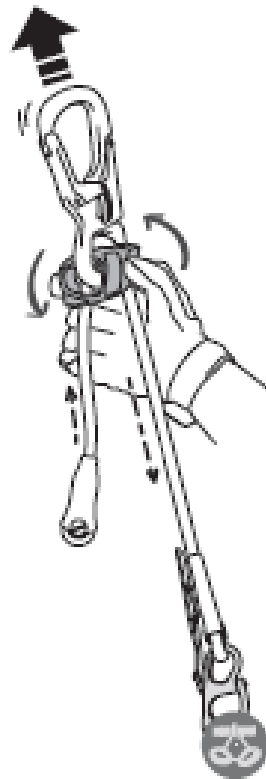

Shorten the tether
Raccourcir la longe

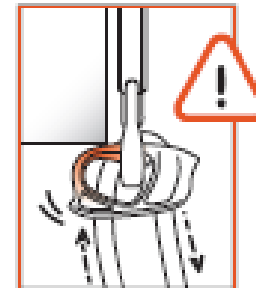
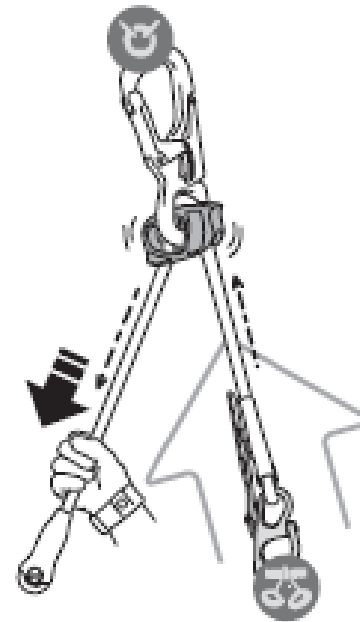

Work positioning
Maintien au travail



Solution 2 : HELO ADJUST

Working principle:

Snap shackle allows for rapid release, even under load, in case of emergency, and pull tab with security snap reduces accidental activation

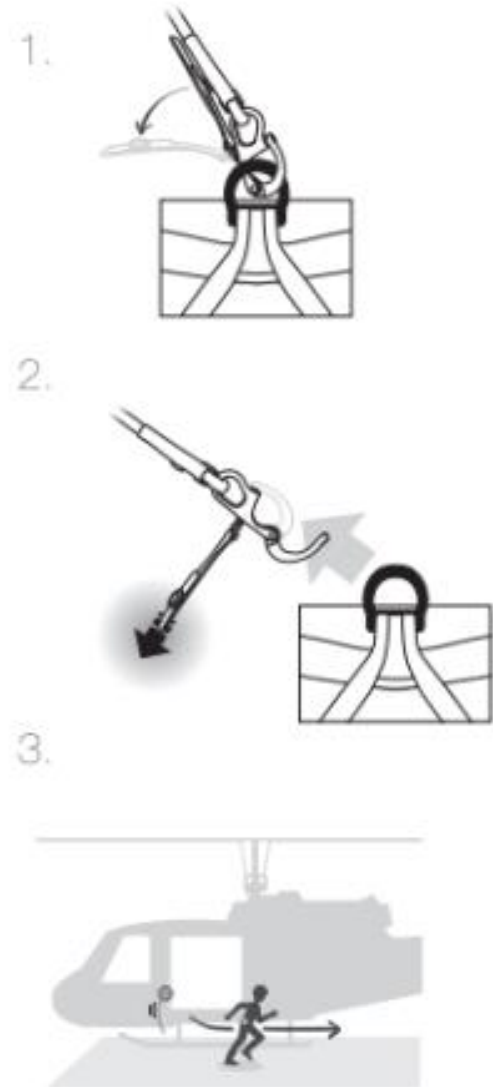

Solution 2 : HELO ADJUST

Specs:

- Weight: 405g (connector included)
- Semi-static rope (65cm)
- Tether max length: 76cm

- Certification: No CE mark
 - Lanyard could be certified as a PPE
 - Snap shackle cannot be certified as a PPE

*Annexe I : Liste exhaustive des genres d'EPI n'entrant pas dans le champ d'application de la présente directive :

DIRECTIVE

1. EPI conçus et fabriqués spécifiquement pour les forces armées ou du maintien de l'ordre (casques, boucliers, etc.).

- Sales conditions:
 - Sale-restricted
 - Make to order (No stock)

WARNING:

The HELO ADJUST is a singular-purpose, sale-restricted tether designed for Military and Law Enforcement operators only who require travel restraint and a quick disconnect function when traveling inside of helicopters. All other unauthorized uses of this tether are prohibited.

PPE regulation 2016/425 to replace PPE directive 89/686

Applicable since 21st of April 2018

Manufacturer can start claiming compliance

Transition period until 21st of April 2019 (Manufacturers)

Manufacturer cannot put PPE according to the directive on the market after this date

Transition period until 21st of April 2023 (Resellers)

Distributors and resellers cannot put PPE certified according to the directive on the market after this date

Main changes



Manufacturer's address



MM/YY

Manufacturing date for products subject to ageing on product and packaging (textile, plastic)



EU type examination validity shall not exceed 5 years

Petzl provides:

- Technical notice  [Download the PDF : technical-notice-LEZARD-1 - 1.40 MB](#)
- Declaration Of Conformity [Download the PDF : CE-Declaration-L01 L01000-Lezard - 0.03 MB](#)
- PPE inspection procedure [Download the PDF - 0.73 MB](#)
- PPE checklist [Download the PDF - 0.23 MB](#)
- FAQ

<https://www.petzl.com/GB/en/Professional/Lanyards-and-energy-absorbers/LEZARD>

Questions / Field feedback...



Thank You!