



Air Warfare Centre - JADTEU



UK Underslung Loads Brief

Sqn Ldr Alan Swan
OC Hels & Trg



Air Warfare Centre - JADTEU



JADTEU – Mission

To *enable the delivery by air* of personnel, machines and materiel through development trials, and training in order to enhance Defence Capability

Aerial
Delivery
(AD)



Technical Graphics,
Media & Photo



Air
Portability
(AP)



Parachute
Test Team
(PTT)



Engineering **(Eng)**



Helicopter
Section
(Hels)



Abseiling,
Fast-
Roping,
Helicopter
Handling
(Trg)





Training Section



**Helicopter Handling
Instructors.**

**Troop Insertion and
Extraction Instructors**



Underslung Load Trials Process

- **SME / Eng Assessment**
- **Develop load preparation notes**
- **Develop rigging scheme**
- **Lift using instrumented sling assembly**
- **Document all lifts**
- **Once satisfied with scheme, produce Static Trial Report**
- **Static trial report used for evidence to gain authority for flight trial**
- **Progress to flight trial to generate flight limitations**
- **Produce Underslung Load Scheme and Final Report**



Air Warfare Centre - JADTEU



Static Testing







Air Warfare Centre - JADTEU

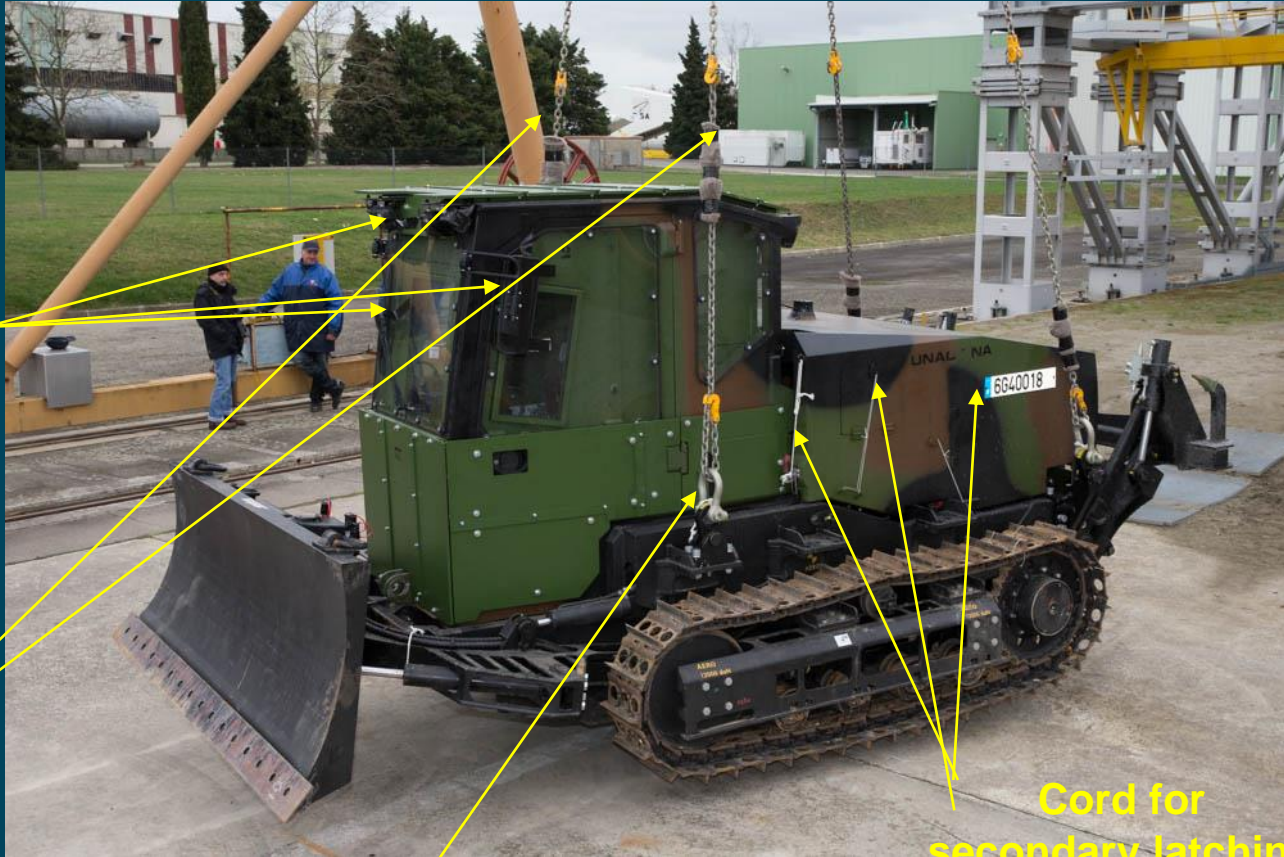

Tape
(Wipers,
Mirrors,
Lights etc.)

Protective Felt

Shackles fitted to lift
points

Cord for
secondary latching



Air Warfare Centre - JADTEU



Flight Trial





Types Of Rigging

Single Hook Operations - All Aircraft

**Tandem Hook Operations – Chinook
Only**



Air Warfare Centre - JADTEU

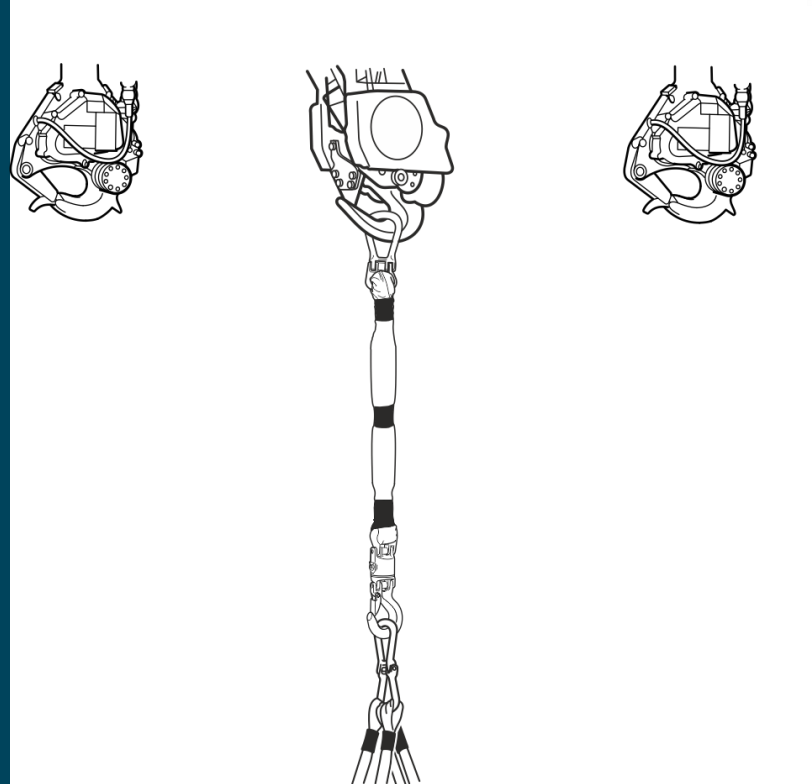

Single Hook Operations



Air Warfare Centre - JADTEU

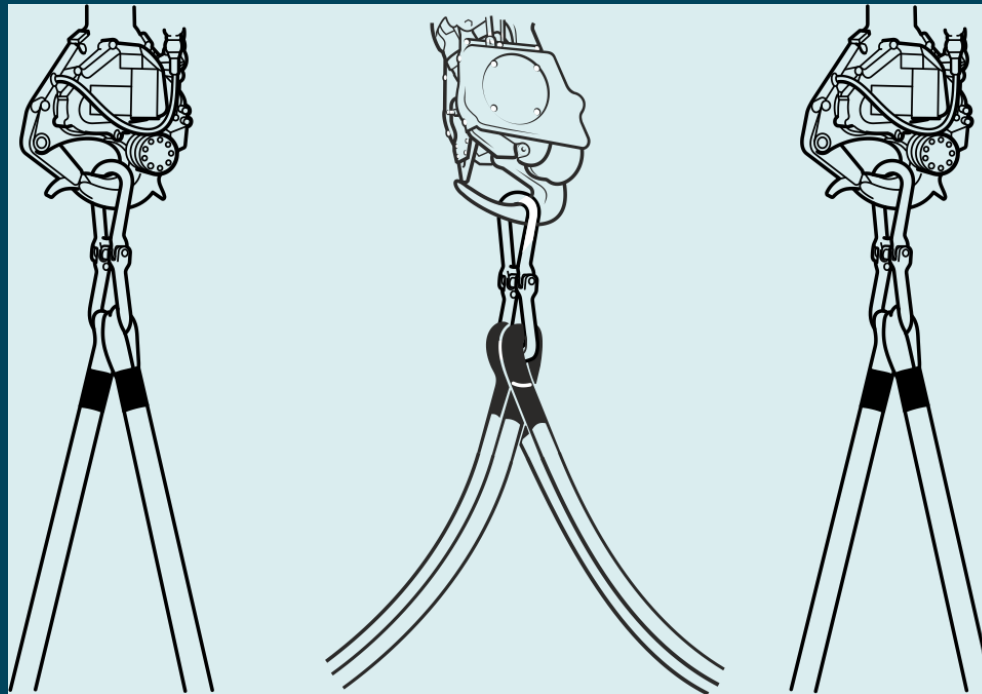

Tandem Hook Redundant Rigging

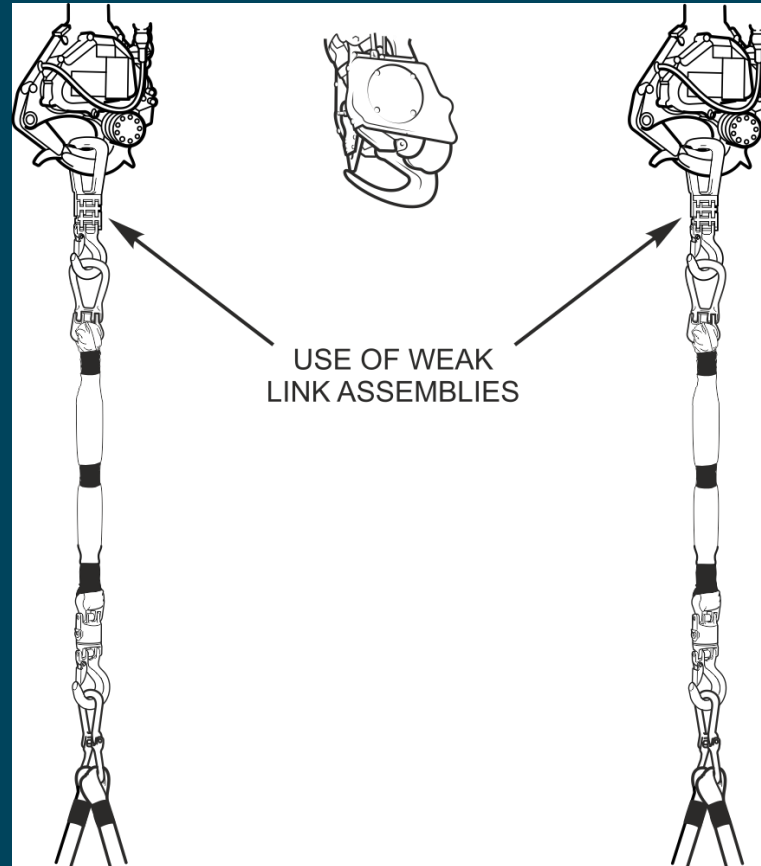

Tandem Hook Long Strop



USL Categories

- **Cleared Load**
- **Authorised Load**
- **Uncleared Load**

WEIGHT INFORMATION

Item		Weight	AUW
TNA Bulldozer	Unarmoured	6250 kg (13778 lb)	6375 kg (13867 lb)
	Armoured	7280 kg (16049 lb)	7405 kg (16326 lb)
Slings equipment		125 kg (277 lb)	-

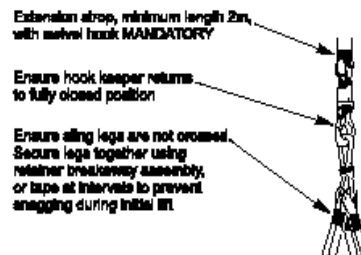

Cleared Load

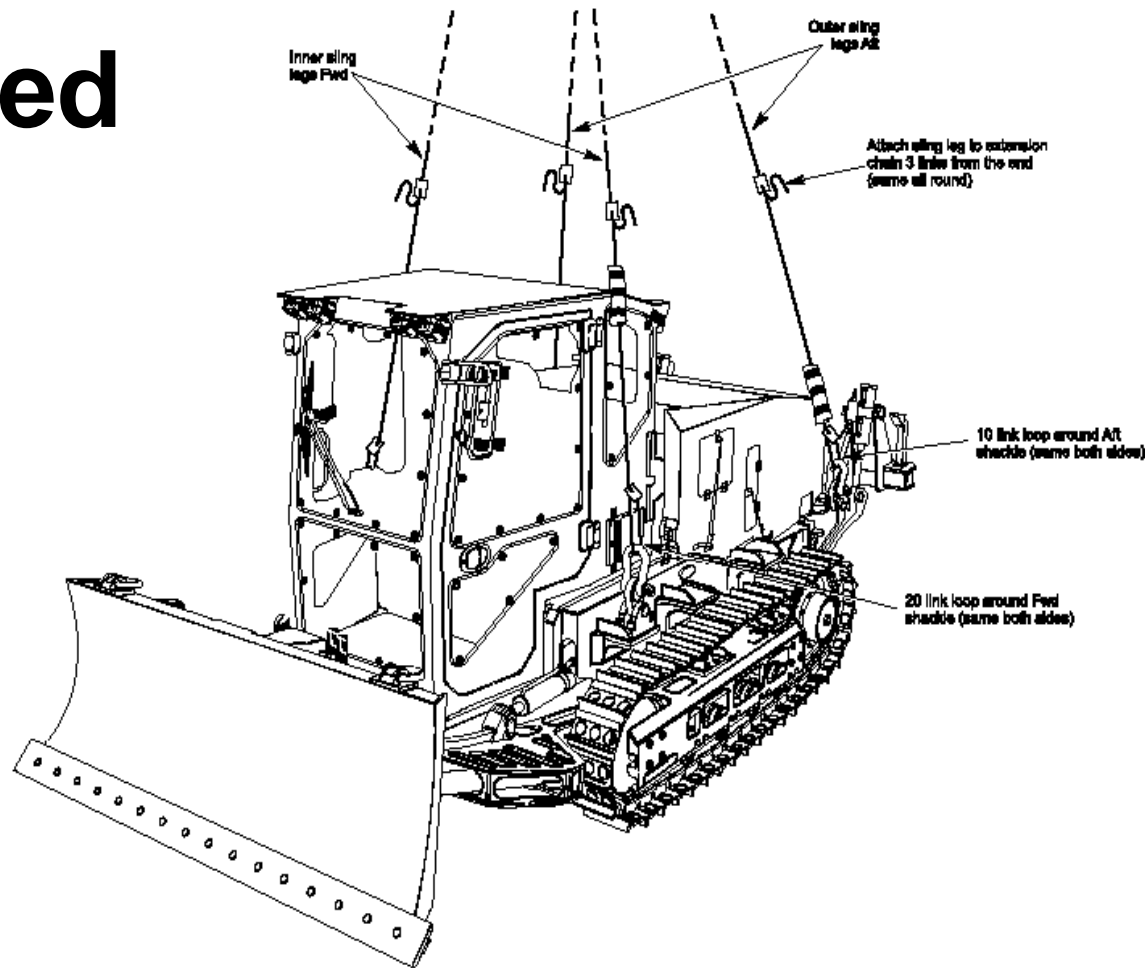

TNA BULLDOZER
Using SML11300 kg



Air Warfare Centre - JADTEU

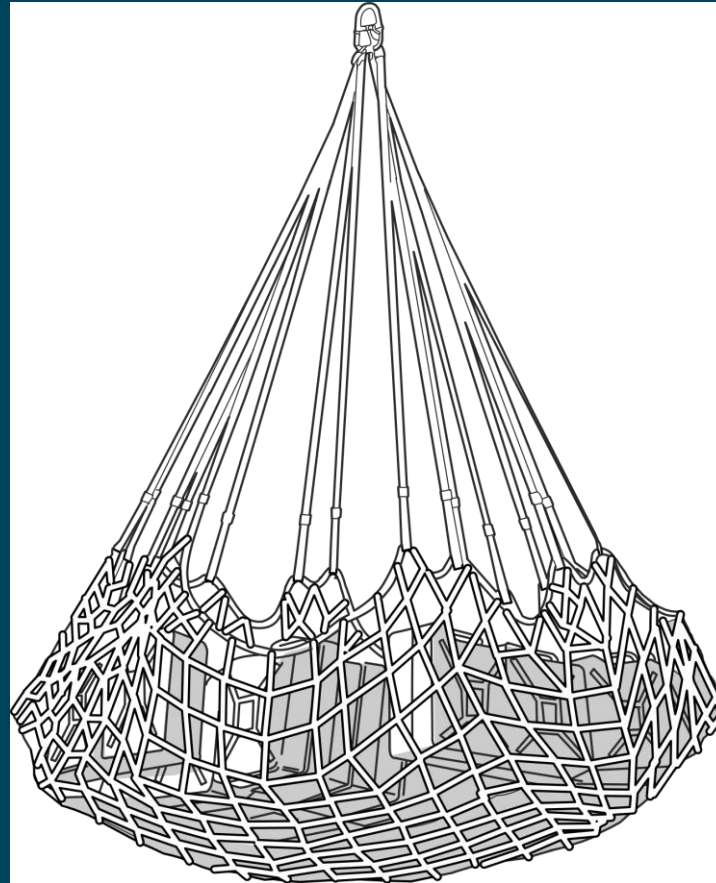

Authorised Load



Uncleared Loads

- Unique Loads
- Normally Once Only
- Normal Underslung Load Equipment
- May Use Belly Bands

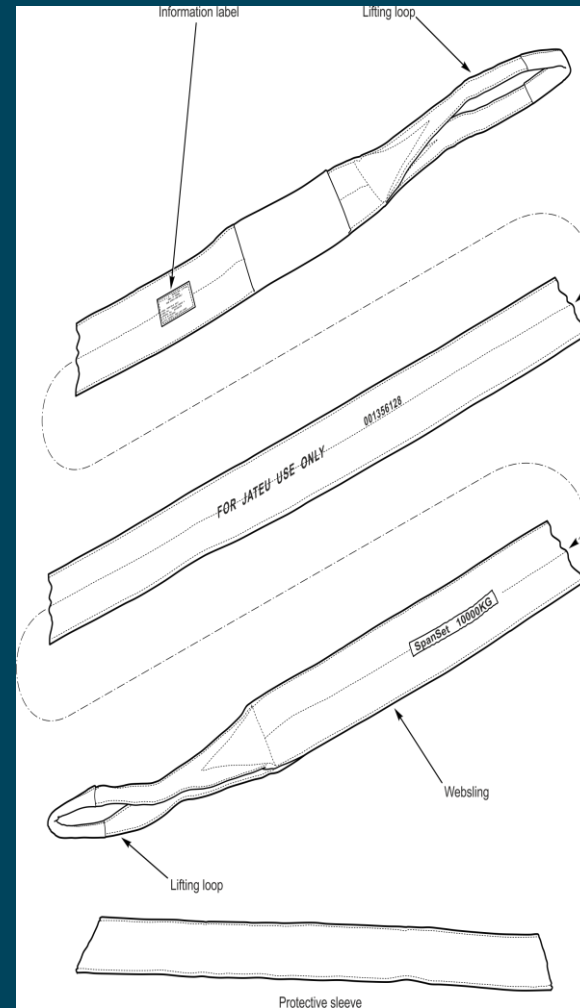



Air Warfare Centre - JADTEU



Jan 2018

**5 Tonne
Natural
Stone
Bridge**

**Snowdonia
North
Wales**





Air Warfare Centre - JADTEU



**Mar
2017**

**Bristol
UK**

**Sea
Harrier**





Documents

- **All our documents are on line**
- **General Underslung Document**
- **Underslung Load Clearances**
- **Roping Manuals**
- **Other JADTEU Documents**



Air Warfare Centre - JADTEU



Any Questions